

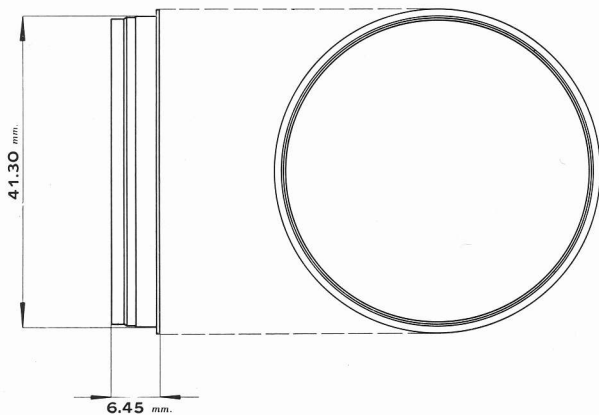

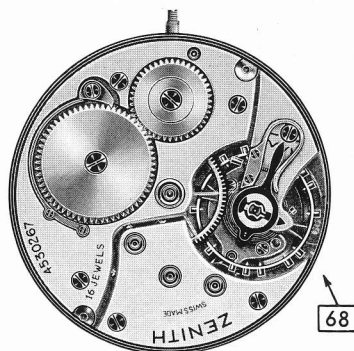

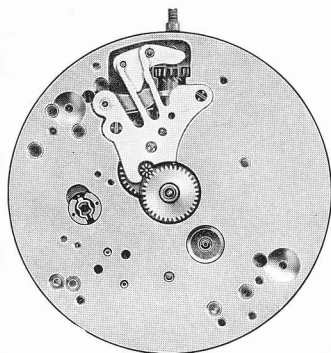

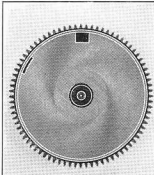



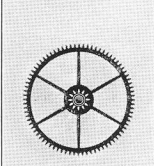
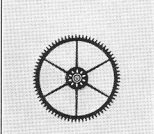
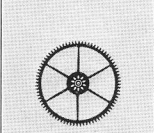

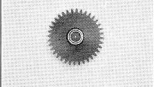
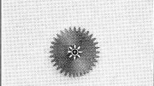

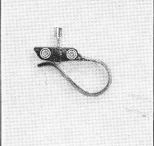



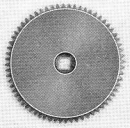









Calibre 68

19" Ancre — 18,000 alternances

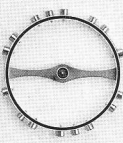

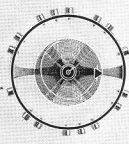
	<p>■ 180 ■ 180/1</p>	<p>Barillet avec arbre Barillet complet (avec ressort)</p>
	<p>■ 195</p>	<p>Arbre de barillet</p>
	<p>■ 200</p>	<p>Roue de centre avec chaussée <i>Indiquer hauteur de chaussée</i></p>
	<p>■ 210</p>	<p>Roue moyenne</p>
	<p>■ 224</p>	<p>Roue de seconde, long pivot <i>Indiquer longueur du pivot dessous</i></p>
	<p>■ 240</p>	<p>Chaussée lanternée <i>Indiquer hauteur</i></p>
	<p>■ 250</p>	<p>Roue des heures <i>Indiquer hauteur de chaussée</i></p>
	<p>■ 260</p>	<p>Roue de minuterie</p>
	<p>■ 302</p>	<p>Raquette pour spiral Breguet</p>
	<p>■ 357</p>	<p>Ressort-régulateur de raquette</p>

	■ 401	Tige de remontoir
	■ 407	Pignon coulant
	■ 410	Pignon de remontoir
	■ 414	Assise de roue de couronne
	■ 415	Rochet
	■ 420	Roue de couronne
	■ 423	Noyau de roue de couronne
	■ 425	Cliquet
	■ 430	Ressort de cliquet
	■ 435	Bascule
	■ 440	Ressort de bascule
	■ 443	Tirette
	■ 445	Ressort de tirette
	■ 450	Renvoi et renvoi intermédiaire
	■ 502	Axe de tirette

	■	705	Roue d'ancre pivotée
	■	710	Ancre montée
	■	719	Balancier sans axe (avec siette)
	■	720	Balancier pivoté avec plateau
	■	722	Balancier avec spiral Breguet
	■	723	Axe de balancier
	■	730	Plateau
	■	735/1	Spiral Breguet réglé, piton triangulaire
	■	770	Ressort de barillet
	■	601/8	Chaton pour roue de centre dessus
	■ ●	605/8	Chaton pour roue moyenne et pour roue de seconde dessus
	■ ●	606	Pierre de roue moyenne et de roue de seconde dessous
	■ ●	615/8	Chaton pour roue d'ancre dessus

■ V. tableau de concordance

● V. tableau de concordance

■ ●	616	Pierre de roue d'ancre dessous et d'ancre dessus et dessous
■	646	Palette d'entrée
■	647	Palette de sortie
■	648	Cheville de plateau
■	714	Tige d'ancre
■	5101	Vis de fixation
■	5110	Vis de ponts
■ ●	5125	Vis de pont d'ancre
■	5357	Vis de ressort-régulateur de raquette (fixation)
■	5415	Vis de rochet
■	5420	Vis de roue de couronne
■ ●	5425	Vis de cliquet
■ ●	5430	Vis de ressort de cliquet
■ ●	5445	Vis de ressort de tirette
■	5739/1	Vis de piton
■ ●	5750	Vis de cadran

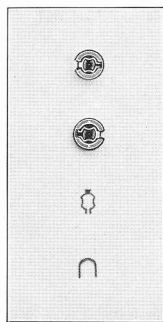

	324	« Incabloc » dessus
●	325	« Incabloc » dessous
●	3241	Ressort dessus et dessous
●	3244	Verrou
●	3242	Pierre de contre-pivot dessus
●	3243	Chaton dessus et dessous
●	3252	Pierre de contre-pivot dessous
●	3255	Vis de fixation « Incabloc » dessous

■ V. tableau de concordance

● V. tableau de concordance

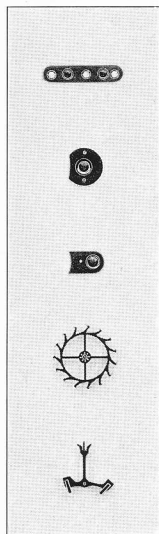
Valable
pour cal.:**68-21**

69	334	Plaque de contre-pivot dessous pour roue d'ancre et ancre
69	336	Plaque de contre-pivot dessus pour roue d'ancre
69	349	Plaque de contre-pivot dessus pour ancre
69	702	Roue d'ancre pivotée, pour deux contre-pivots
69	713	Ancre montée, pour deux contre-pivots
69	602	Pierre de roue de centre dessous
69	615/1	Pierre de roue d'ancre dessus, dessous et d'ancre dessus et dessous pour contre-pivot
69	615/1/8	Chaton pour roue d'ancre dessus, pour contre-pivot
69	717	Tige d'ancre pour deux contre-pivots
69	5334	Vis de plaque de contre-pivot dessous pour roue d'ancre et ancre
69	5336	Vis de plaque de contre-pivot dessus pour roue d'ancre
69	5349	Vis de plaque de contre-pivot dessus pour ancre